

## ECDIS

Electronic Chart Display and Information System

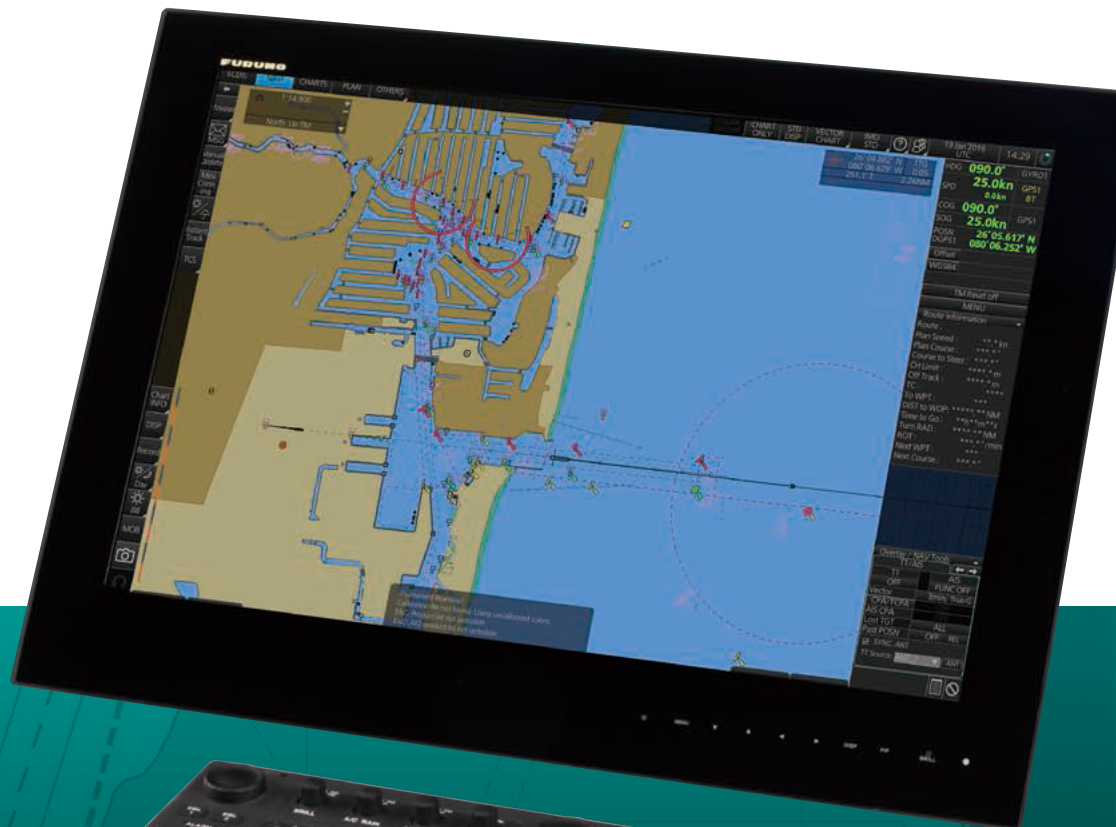

Models:

**FMD-3200** (with 19" LCD)

**FMD-3300** (with 27" wide or 23.1" LCD)

**FMD-3200-BB** (black-box type)

# Fast, intuitive route planning and

# ECDIS

Electronic Chart Display and Information System

Models: FMD-3200 (with 19" LCD) / FMD-3300 (with 27" wide or 23.1" LCD)



## ► Multifunction display capability, featuring ECDIS, Conning Information Display, Radar/Chart Radar\* and Alert Management System\*\*

\* a radar sensor needs to be integrated in the network.

\*\* Radar and Alert Management System display capabilities are to be implemented as software upgrade. (option)



Radar

ECDIS

Conning Information Display

## ► Instantaneous chart redraw delivered by FURUNO's advanced chart drawing engine, making redraw latency a thing of the past

Instantaneous chart redraw



## ► Intuitive new user interface offers fast, precise route planning, monitoring and navigation data management

## ► Interface with existing FAR-21x7/FAR-28x7 series Radar for Radar overlay, target track info, route and waypoint exchange via Ethernet

\* Software update on FAR-21x7/FAR-28x7 series might be necessary depending on the program number.

## ► Complies with the following IMO and IEC regulations:

- IMO MSC.232(82)
- IMO A.694(17)
- IEC 61162-1 Ed. 4
- IEC 61162-2 Ed. 1
- IEC 61174 Ed. 3
- IEC 62288

## ► 27" wide LCD monitor (model: MU-270W) selectable

- Easy switching of the screen between DVI1 and DVI2 with a locally supplied switching box
- Automatic switching the signal source from DVI1 to DVI2, when the DVI1 signal fails

## ► Compatible cartography

- IHO/S-57 Edition 3 vector chart (IHO S-63 data protection scheme)
  - Admiralty Vector Chart Service by UKHO
  - C-MAP ENC
  - Jeppesen Primar ECDIS Service
- ARCS raster chart
- C-MAP Professional+\*
  - \*C-MAP Professional+ is a private chart, hence not construed as replacement for paper chart.

## ► Interface with Jeppesen Dynamic Licensing Service available

## ► Compatibility with Admiralty Information Overlay (AIO) for further navigation safety

Additional AIO layer includes all Admiralty Temporary and Preliminary Notices to Mariners as well as additional ENC Preliminary Notices to Mariners, i.e., reported navigational hazards that have been incorporated into paper chart but have yet to be included in ENCs. The service is free of charge as part of Admiralty Vector Chart Service (AVCS) by UKHO.



Electronic Navigational Chart

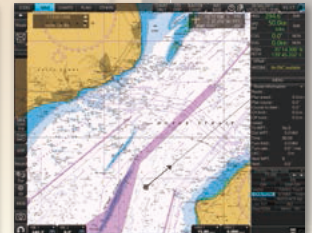

Raster Navigational Chart

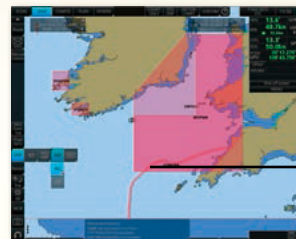

AIO data layer displayed



Place the cursor on the AIO object and right-click to open the contextual menu. Select "Object INFO" to open the chart object window.

### Chart object window

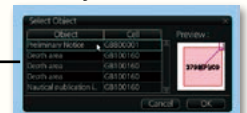

On the chart object window, select the AIO object and click "OK" to view the details.

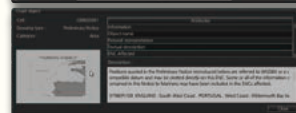
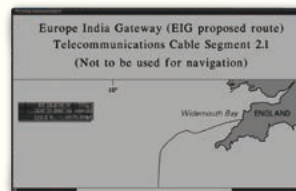

The full text of the Notice to Mariners as well as associated diagrams can be displayed subsequently.

## ► Ease of installation and maintenance thanks to simplified cabling in the sensor-to-ECDIS/Radar interface delivered by common sensor adapter

Sensor Adapter acts as central medium to gather all the sensor data and collectively feed it to all FMD-3200/3300 ECDIS and FAR-3000 Chart Radar in the system. Since sensor adapter can be extended to cover all the sensors within the system, individual cabling in the sensor-to-ECDIS/Radar interface can be greatly reduced.



Sensor Adapter  
MC-3000S/3010A/3020D/3030D

Navigation sensors can be directly interfaced with the ECDIS processor's 8 serial I/O ports. Sensor adapters are required under the following conditions:

- the sensor data is to be shared amongst multiple networked ECDIS and Radar systems,
- the number of sensors interfaced is more than the number of the ports the processor has (8 serial I/O ports, 1 digital IN and 6 digital OUT), and/or
- the networked sensors include analog sensors.

In order to integrate onboard sensors into the navigation network, the sensor adapter may be interfaced with the switching hub HUB-100 from which distribution of the sensor data throughout the network is possible. Alternatively, multiple sensor adapters may be interfaced via Ethernet to integrate onboard sensors for use in the shipboard network.

### System diagram for the current Model

Model:  
FEA-2107/2807

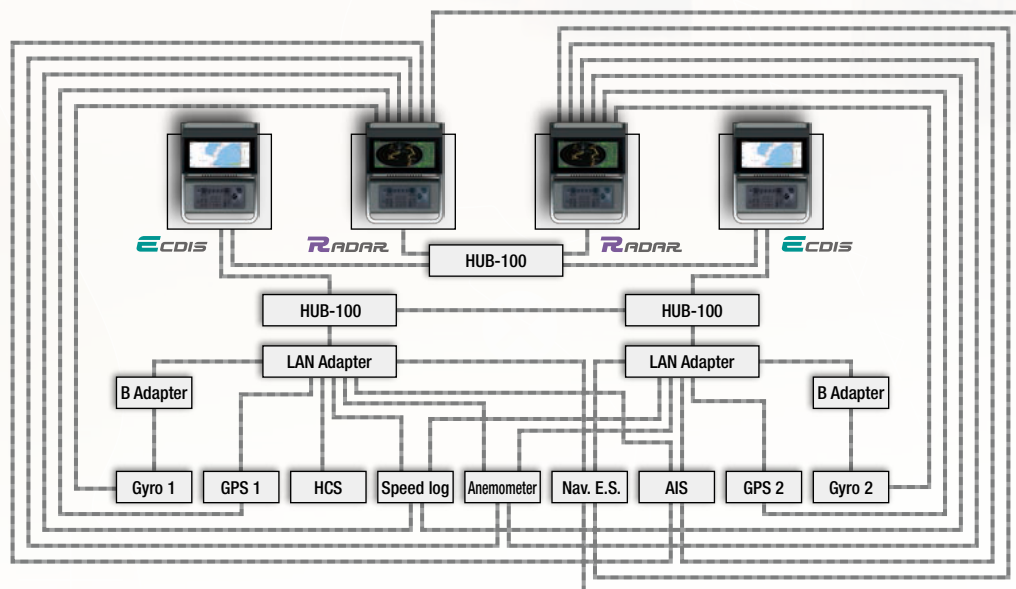

### System diagram for the new Model

Models:  
FMD-3200/3300

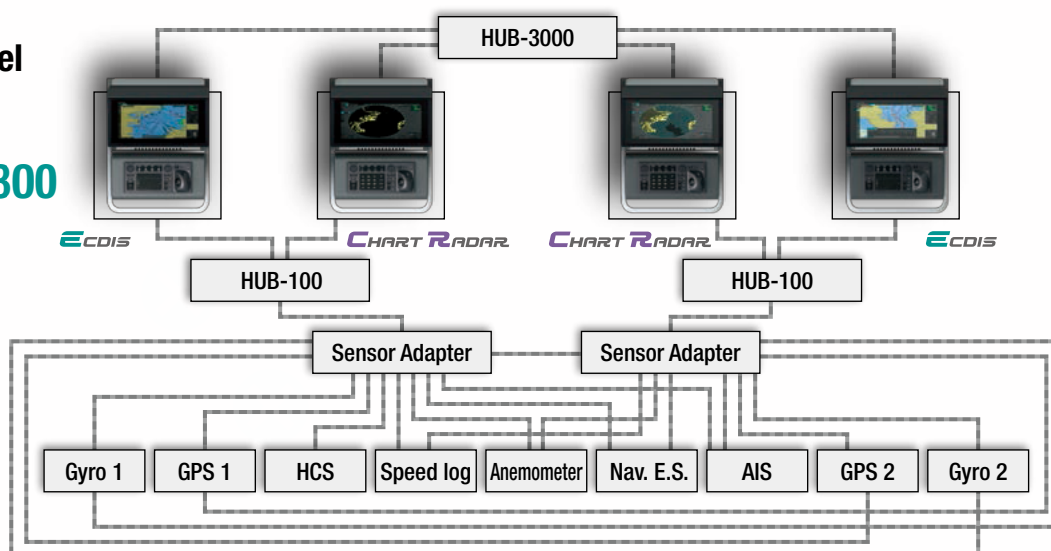

# FURUNO's new user interface delivers straightforward, task-based operation

## ECDIS Control Units

The operator control of the FMD-3200 and FMD-3300 can be done with the ECDIS Control Unit RCU-024 or the Trackball Control Unit RCU-026. All functions of the ECDIS can be accessed by using the trackball, scrollwheel and left/right clicking.



ECDIS Control Unit RCU-024



Trackball Control Unit RCU-026

- 1 Press "EBL 1" and "EBL 2" to activate/deactivate respective EBL; and rotate the encoder to adjust active EBL.
- 2 Rotate to adjust brilliance level of the FURUNO monitor; and press to select display palette.
- 3 Rotate to adjust radar gain on the radar overlay.
- 4 Press "VRM 1" and "VRM 2" to activate/deactivate respective VRM; and rotate the rotary encoder to adjust active VRM.
- 5 For acknowledgement of alerts generated.
- 6 Rotate to select items within the InstantAccess bar™; and press to confirm the selection of the item.
- 7 Full QWERTY keyboard for easy entry of route, event and waypoint names.
- 8 Following functions are assigned for each key:  
UNDO: to undo the last operation  
RANGE: to select chart scale
- 9 Following functions are assigned for each key:  
VIEW/HIDE: to show/hide the I.A. bar and route information window  
ACQ/ACT: to activate selected active AIS target  
TARGET DATA: to display the detailed target data for selected TT/AIS  
TARGET CANCEL: to sleep the selected active AIS target
- 10 USB port for charts update, import/export, WP/routes, user setting.
- 11 Trackball Module  
Trackball module consists of four parts, each of which has the following functions:  
trackball: to move the cursor and select an object  
left-click: to perform/confirm the action related the selected object  
right-click: to display contextual menu while a cursor is on the display area, and to cancel action done on the selected object  
scrollwheel: to select menu items

**Contextual Menu**

Right-clicking on the screen will open the contextual menu containing all the available actions related to the position of the cursor, i.e., chart object, data box, etc., hence providing quick access to tasks required.

## Task-based user interface realized by combination of Status bar and InstantAccess bar providing quick access to the needed tasks/functions

The user interface of the FMD-3200/FMD-3300 centers on carefully organized operational tools: Status bar and InstantAccess bar™. The Status bar at the top of the screen contains information about the operating status, i.e., MFD operating mode, the ECDIS operation modes, etc. InstantAccess bar™ at the left-hand side of the screen contains all the tasks (functions/actions) corresponding to the ECDIS operation mode currently selected. These operational tools deliver straightforward, task-based operation by which the operator can quickly perform navigational task without having to go deeper into an intricate menu tree.

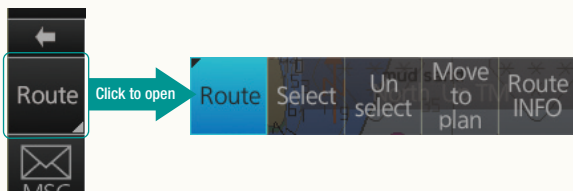
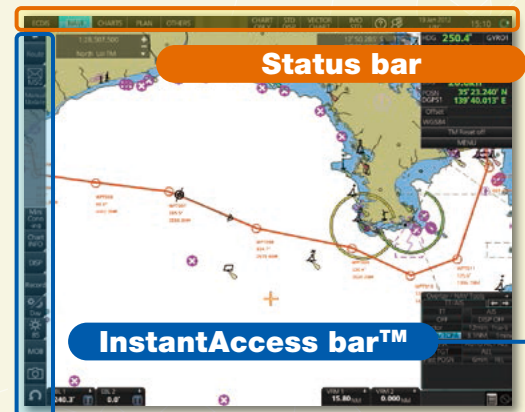

### Drop-down menu to facilitate streamlined operation

on buttons in the Status bar and InstantAccess bar™ indicate that there are hidden options of actions/tasks to be performed in the sub-layer, which can be initiated by left-clicking the buttons. This way, the operator can quickly gain access to the related tasks.

## Status bar



### 1 MFD operating mode selector

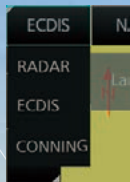

By clicking this button, the MFD operating mode selector will open.

### 2 Operation Mode

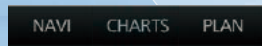

These three buttons give quick access to the three ECDIS operation modes: "Monitor mode", "Chart Maintenance mode" and "Plan mode". Once an operation mode is selected, the upper part of the InstantAccess bar™ will change accordingly, providing quick access to the tasks specific to each of the ECDIS operation modes.

### 3 Other buttons on the Status bar



Click to play back log.



Shows only the chart, while long-pressed by the left-click key.



Click to restore the IMO standard display.



Click to set priority order of chart to be displayed.



Click to select IMO chart display setting: IMO BASE, IMO STD or IMO-ALL.



Click to display the operator's manual, ECDIS program number and system information.



Click to select, manage and set the user profile.

## InstantAccess bar™

When clicking ← on the InstantAccess bar™, the InstantAccess bar™ will retract to the edge of the screen. By clicking the hidden bar at the edge of the screen, the InstantAccess bar™ will come back in.

The upper part of the InstantAccess bar™ contains the list of available tasks/functions specific to each of the ECDIS operation modes selected, hence providing quick access to the needed tasks/functions to be performed. While the menu items of the upper part of the InstantAccess bar™ change according to the mode selected, the lower part of the InstantAccess bar™ is static for all modes, except for "Mini Conning", which is only available in the "Monitor mode" and "Plan mode".

### 1 Items on the lower part of the InstantAccess bar™:



Click to show and hide the mini conning display, only available in the "Monitor mode" and "Plan mode".

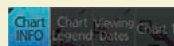

Click to view overview of ECDIS chart symbols.

Click to open a chart viewing date setup window.

Click to view various data about the chart currently displayed, the contents of which depend upon the type of chart displayed.



Click to display Admiralty Information Overlay.

Click to split the screen in two (two-way split screen).



Click to record user/position events to the event log as well as to access various logs to observe, including: navigation logs (details log, voyage log and chart usage log), target log and alert log.

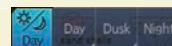

Click to select a color palette (color and brilliance set of the screen presentation) to match the ambient lighting conditions.

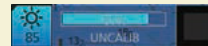

Click to summon display brilliance level adjustment window where the brilliance level can be adjusted either manually (by gauge) or automatically (by clicking the automatic brilliance adjustment button, next to the brilliance gauge).



Click to enter Man Overboard mark on the chart.



Click to take a screenshot.



Click to undo/redo the past actions.

Click to enter setting windows for chart/symbol display as well as chart alert.

Click to activate on-screen keyboard.



Click >>> to open

Click <<< to retract

1

# Items on the upper part of the InstantAccess bar™:

## Monitor Mode

In the Monitor Mode, ship's behaviour can be monitored in relations to the planned route. Various voyage monitoring tools are incorporated into the InstantAccess bar™.

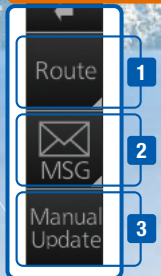

- 1 **Route** Select Un select Move to plan Route INFO  
**Select:** Click to open route selecting menu window to select the route to monitor.  
**Unselect:** Click to stop monitoring the route.  
**Move to plan:** Click to transfer the route currently being monitored to the Plan Mode in order to amend the route.  
**Route INFO:** Click to open the route information window where the detailed parameters set for each waypoint within the route as well as the details of the user chart can be verified. Also, notes/cautions on status of the monitored route as well as user chart can be viewed.



Click to open the AIS/NAVTEX message menu window from which the operators can handle AIS/NAVTEX messages, i.e., sending, viewing and deleting the messages.

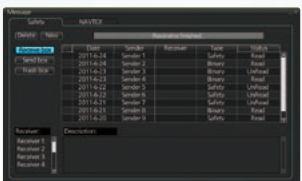

AIS/NAVTEX message dialog box



Click to open the manual update menu window by which the operators can update the electronic chart by inserting chart update symbols manually, according to the Notices to Mariners, NAVTEX warnings, etc. Manual update of the chart is required to ensure that the chart is kept up to date at all times. When the official chart update containing the changes by the manual update is made, the operator can delete the manual update symbols through the manual update menu window.



Route monitoring



Radar overlay

## Chart Maintenance Mode

The Chart Maintenance Mode allows the operators to handle charts to be used in the system

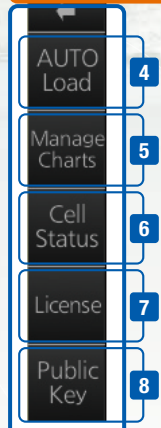

- 4 **AUTO load**  
Click to start automatic installation of the chart data from the chart CD or DVD ROM.
- 5 **Manage charts**  
Click to manage charts, i.e., grouping chart cells by purposes, deleting unnecessary chart cells, etc.
- 6 **Cell status**  
Click to view the chart catalog that shows general information about the charts installed in the system, i.e., coverage, license status, availability and other status information.
- 7 **License**  
Click to open the chart license menu window where the operators can view the permit status of the chart installed. Also, the operators can install, backup, restore and export the chart licenses from the same menu window.
- 8 **Public key**  
Click to open Public Key management window. This allows user to change the Public Keys which are used to authenticate the source and integrity of the chart materials used in ECDIS.



chart license menu window

## Plan Mode

In the Plan mode, the operators can generate and edit route plans as well as user charts. Also, various detailed reports, generated by ECDIS, on planned routes as well as user charts can be viewed. All these tasks can be accessed from the InstantAccess bar.

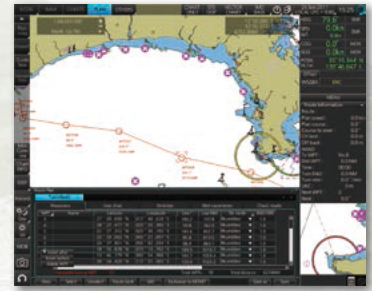
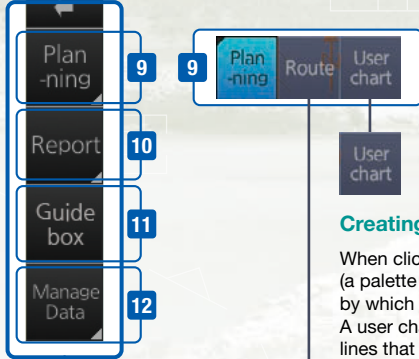

Route planning

### Creating User Chart:

When clicking on "User chart", user chart tools (a palette and a menu window) will be displayed by which operators can create a user chart. A user chart is a layer consisting of marks and lines that can be produced and overlaid onto the chart. It is intended for indicating safety-related areas and objects.



User Chart Tools



### Route Planning:

Once left-clicking on "Route", a route planning menu window will open. The operators can use the trackball to enter waypoints directly onto the chart. After entering a waypoint, the operators can edit name, steering mode, radius, channel limit and other parameters of the waypoints on the menu window.



Route Planning Dialog Box



A guide box instantly tells the operators the range and bearing between the last waypoint and the cursor position as you drag the cursor.

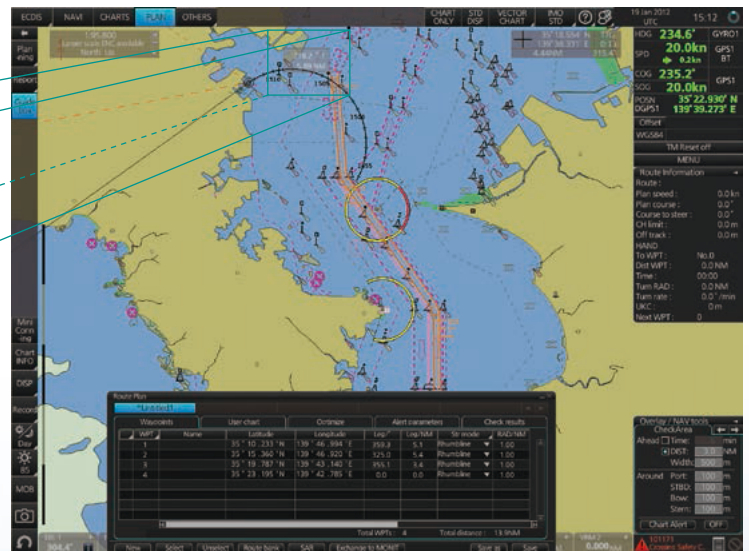

Route Planning Display

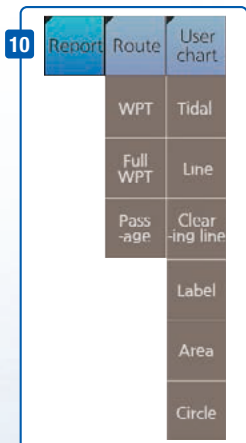

### Quick access to various reports:

Route reports on waypoints and passage plan as well as user chart reports on tidals, lines, user-entered objects and user-defined areas can be directly accessed for viewing from the InstantAccess bar.



Click to open the data management windows for routes as well as user charts where selected routes and user charts can be deleted.

# FURUNO's provision of thoroughgoing ECDIS training

Proper training is required to ensure an efficient and safe operation of vessels as well as to optimize the advantages of having ECDIS onboard. Advantages include less time spent on chart management and voyage planning and increased safety through the proper setup and operation of the ECDIS, which can remarkably reduce the risk of groundings, etc. Training comes in many forms and the crew should undergo both generic training to get full understanding of the ECDIS as a concept, the rules governing ECDIS and the influences on the bridge operation. Crews should also receive ECDIS familiarization training, which helps the operator familiarize themselves with the specific ECDIS onboard the vessel. FURUNO offers the ECDIS trainings through its INS Training Centers (INSTC in Copenhagen and Singapore) as well as other training facilities signed up as NavSkills™ training facilities. NavSkills™ training solution is the service and support for maritime training centers and shipowners, who are looking to establish their own training facilities in full compliance with STCW and IMO standards. NavSkills™ training package includes provision of training simulators, provision and update on course materials and curriculum, training for instructors, certification of the trainees by INSTC and much more.



## IMO ECDIS Model Course 1.27 (Generic ECDIS training)

STCW requires that all masters and officers in charge of a navigational watch (Officer of the Watch: OOW) on a ship fitted with ECDIS shall have completed a generic ECDIS course and hold an ECDIS certificate in accordance with IMO model course 1.27.

This ECDIS training provides the trainees with knowledge of the ECDIS as a system, its operation, electronic chart materials and practical navigation. Also, the course includes terms and conditions for implementing paperless navigation. The training course focuses upon many advantages and safety features obtained by operating ECDIS. The limitations of ECDIS are taught throughout this training course.

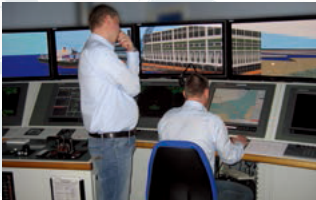

This training concludes with 3 compulsory tests, and, if passed, a certificate is issued, which confirms the trainees' successful completion of the generic ECDIS training in accordance with IMO Model Course 1.27, reviewed by DNV SeaSkill™.

The course is available at INSTC Denmark.

## FURUNO ECDIS familiarization training course

FURUNO ECDIS familiarization training provides trainees with specific knowledge about functionality and effective use of FURUNO ECDIS for navigation.

The training covers the following aspects of FURUNO ECDIS operation:

- Familiarization with available functions
- familiarization with the menu structure
- Display setup
- Setting safety value
- Route planning
- Route monitoring
- Recognition of alarm and malfunction indicators and the actions to be taken
- Changing over to backup systems
- Loading and updating of charts and licenses
- Updating software

The training concludes with a compulsory test. Upon successful completion of the test, the navigators are issued with a certificate that confirms the successful completion of the FURUNO ECDIS familiarization training course. This training complies with the STCW and ISM Codes, audited and certified by ClassNK (INSTC Denmark and INSTC Singapore).

The course is available at INSTC in Denmark and Singapore. Also, NavSkills™ training facilities around the globe offers the range of ECDIS training services. For details of locations and training availability, please visit [www.navskills.com](http://www.navskills.com).





# programs

## ► Contact Info



FURUNO INSTC

### FURUNO INS Training Center Denmark

Hammerholmen 44-48, DK-2650 Hvidovre, Denmark  
 Phone: +45 36 77 40 12  
 E-mail: instc-denmark@furuno.com

### FURUNO INS Training Center Singapore

No. 17, Loyang Lane, Singapore 508917  
 Phone: +65 6745 8472  
 E-mail: instc-singapore@furuno.com

## NavSkills

NavSkills™ facilities

Please find the contact information as well as the training service availability of each of the NavSkills™ training facilities at the FURUNO training service web site: [www.navskills.com](http://www.navskills.com) where you can also find the detailed course descriptions as well as other practical information.

### Monitor Unit

**MU-190** 8.8 kg 19.4 lb

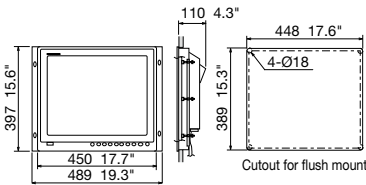

**MU-231** 12.8 kg 28.2 lb

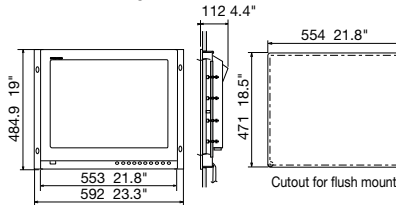

**MU-270W** 13 kg 28.7 lb

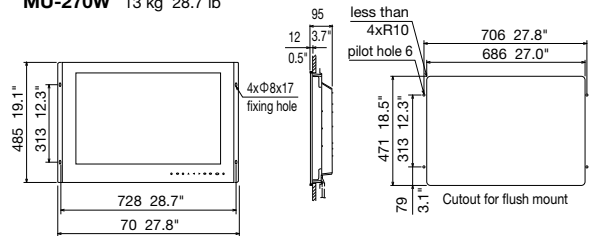

### ECDIS Control Unit

**RCU-024**

3.3 kg 7.3 lb

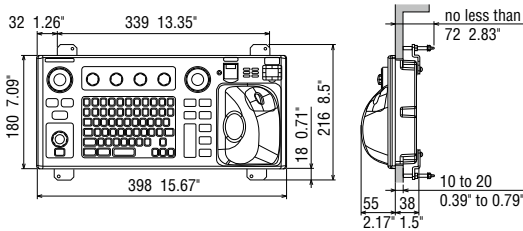

### Trackball Control Unit

**RCU-026**

1.5 kg 3.3 lb

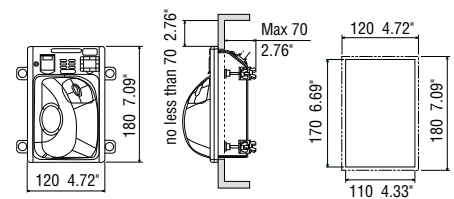

### Processor Unit

**EC-3000**

14 kg 30.9 lb

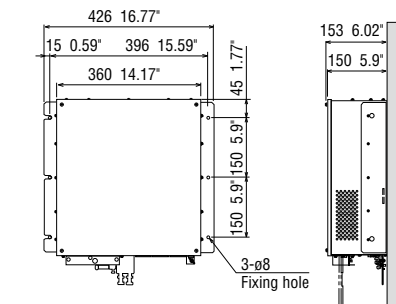

### Switching Hub

**HUB-100**

1.5 kg 3.31 lb

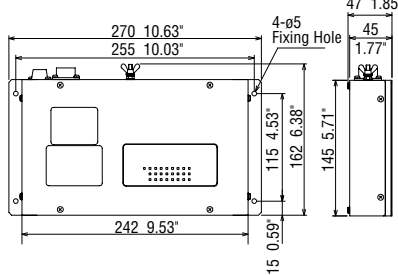

### Intelligent Hub

**HUB-3000**

1.5 kg 3.31 lb

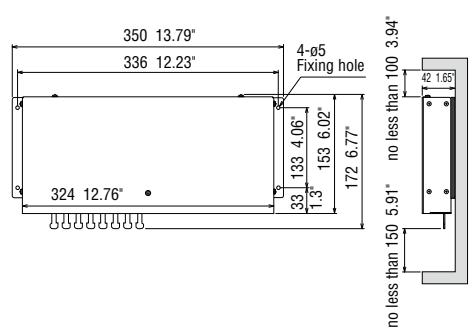

### Sensor Adapter

**Serial**

**MC-3000S**

1.5 kg 3.3 lb

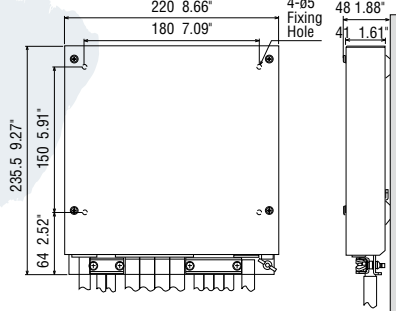

**Analog**

**MC-3010A**

0.8 kg 1.8 lb

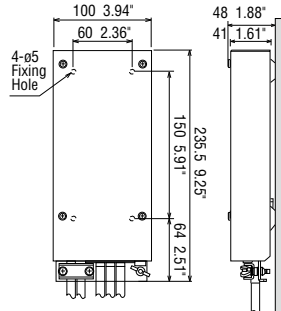

**Digital In**

**MC-3020D**

0.8 kg 1.76 lb

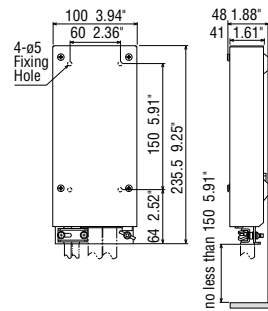

**Digital Out**

**MC-3030D**

0.8 kg 1.76 lb

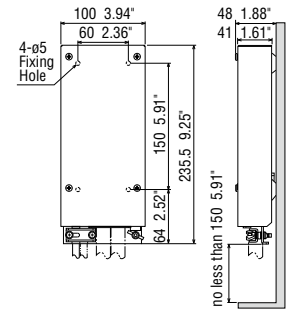

# SPECIFICATIONS

Product Name	ELECTRONIC CHART DISPLAY AND INFORMATION SYSTEM	
Standards	IMO MSC.232(82), IMO A.694(17), IMO MSC.191(79), IEC 61174 Ed. 3, IEC 61162-1 Ed. 4, IEC 61162-2 Ed. 1, IEC 62288, IEC 60945 Ed. 4	
Monitor Unit	FMD-3200	MU-190, 19" color LCD, SXGA (1284 x 1024 pixels)
	FMD-3300	MU-270W, 27" wide color LCD, WUXGA (1920 x 1200 pixels) or MU-231, 23.1" color LCD, UXGA (1600 x 1200 pixels)
	FMD-3200-BB	Third-party monitor supporting SXGA, UXGA, WUXGA
Chart Materials	IMO/IHO S57 edition-3 ENC vectorized material (IHO S-63 ENC data protection scheme), ARCS rasterized material, C-MAP and CM-93/3 vectorized materials	
Display Modes	True Motion	North-up, Course-up
	Relative Motion	North-up, Course-up, Route-up, Heading-up
Data Presentation	Own Ship	Own ship's mark/trip and numeral position in lat/lon, speed and course
	Target Tracking (TT: ARPA, AIS)	Range, bearing, speed, course, CPA/TCPA Target information from AIS (waypoint, ship's hull and status)
	Cursor	EBL, VRM
Alarm Information	Waypoint, route monitoring and several alarms Navigation by result from external position sensor	
Position Calculation	Dead reckoning with gyro and log Data from gyro, log, and position sensors to be fed to mathematical filter to generate highly accurate position and speed	
Navigation Planning	Planning by rhumb line, great circle	
Navigation Recording	Latest 12 hours of navigation data to be recorded	
Route Monitoring	Off-track display, waypoint arrival alarm, shallow depth alarm	
User Chart	Creation and display of user chart (up to five user charts can be incorporated into a route plan; up to 200 points inclusive of lines and symbols can be included per 1 user chart)	
MOB (Man Overboard)	Position, and other data at time of man overboard can be recorded and displayed upon pressing the MOB button on the screen	
Interface	DVI	2 ports DVI-D (Video signal from DVI No.1 and No.2 is identical) 1 port DVI-D or analog RGB (conning display or VDR selectable)
	LAN	3 ports, Ethernet 1000 Base-T (1 port is for radar sensor only)
	USB	4 ports, USB 2.0 type-A
	COM	2 ports, RS-485 for brilliance control
	Serial I/O	8 ports, IEC61162-1/2 (2 ports), IEC61162-1 (6 ports) Sentences: (IN) ABK, ALR, CUR, DBT, DPT, DTM, ETL, GGA, GLL, GNS, HDT, HTD, MTW, MWV, NRX, OSD, PRC,RMC, ROT, RPM, RSA, RSD, THS, TLL, TRC, TRD, TTM, VBW, VDM, VDO, VDR, VHW, VTG, XDR, XTE, ZDA (OUT) ABM, ACK, BBM, EVE, HTC, OSD, VBW, VDR, VSD, XTE
	Digital IN	1 port, ACK signal input
Contact Closure	6 ports: 1 port for system fail, 1 port for power fail, 2 ports open and 2 ports close	

## SENSOR ADAPTER

Control and Serial Input	LAN	1 port, Ethernet 100 Base-TX
	Serial	8 ports, IEC 61162-1/2 (4 ports), IEC 61162-1 (4 ports)
	Contact Closure	1 port for power fail, normal close or normal open
Analog Input	3 ports/unit, -10 to +10V or 0 to 10V, 4 to 20 mA, selectable	
Digital Input	8 ports/unit, normal close or open, selectable	
Digital output	8 ports/unit, normal close or open, selectable	

## POWER SUPPLY

Processor Unit	100-115/220-230 VAC, 1 phase, 50/60 Hz
Sensor Adapter	24 VDC, 1.4 A
Monitor Unit	100-230 VAC, 1 phase, 50/60 Hz

## ENVIRONMENTAL CONDITION

Ambient Temperature	-15°C to +55°C	
Relative Humidity	93 % or less at 40°C	
Degree of Protection	Processor Unit	IP20 (IP22: option)
	Sensor Adapter	
	Intelligent HUB	
	Control Unit	IP22
Vibration	IEC 60945 Ed. 4	

## EQUIPMENT LIST

### Standard

- 1 Monitor Unit MU-190 for FMD-3200, MU-270W/231 for FMD-3300 1 unit
- 2 Processor Unit EC-3000 1 unit
- 3 ECDIS Control Unit RCU-024 or Trackball Control Unit RCU-026 (specify when ordering) 1 unit
- 4 Standard Spare Parts and Installation Materials 1 set

### Option

- 1 Sensor Adapter:
  - MC-3000S Control Serial
  - MC-3010A Analog
  - MC-3020D Digital IN
  - MC-3030D Digital OUT
- 2 Trackball Control Unit RCU-026 (for remote control) 1 unit
- 3 Switching Hub HUB-100 for sensor network 1 unit
- 4 Intelligent Hub HUB-3000 for interswitch network 1 unit
- 5 AC/DC Power Supply Unit PR-240 1 unit
- 6 DVI-analog RGB conversion kit 1 set
- 7 Installation Materials 1 set

## INTERCONNECTION DIAGRAM

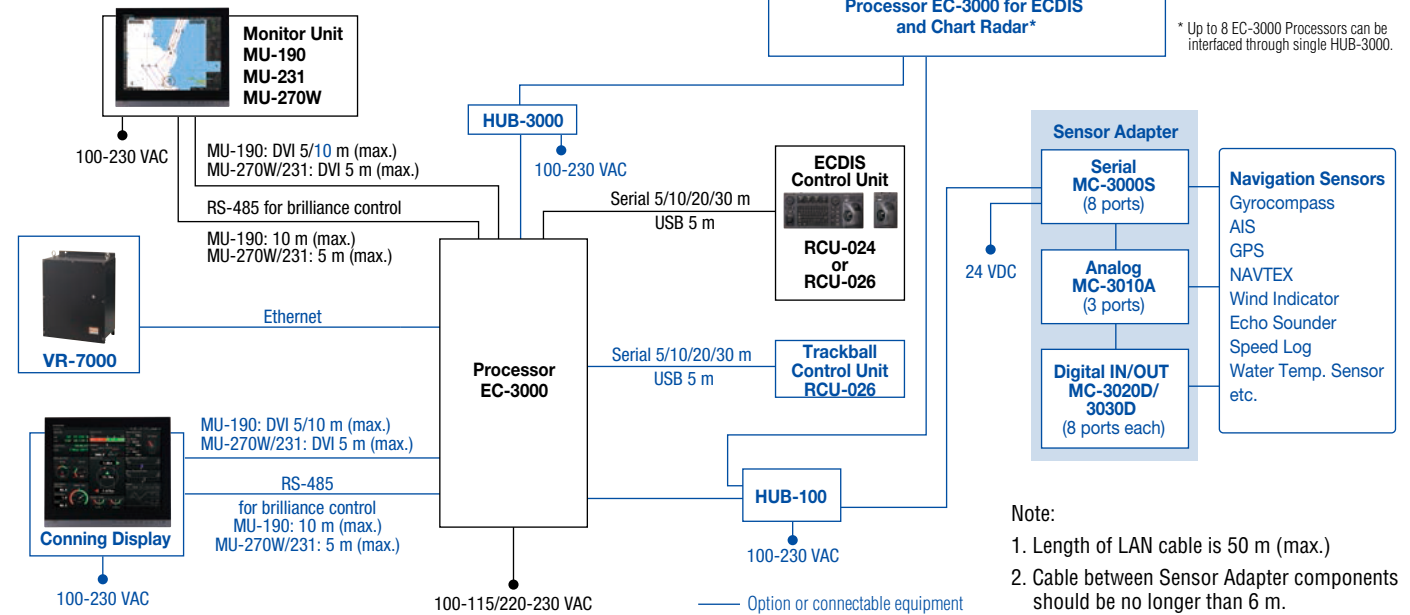

All brand and product names are registered trademarks, trademarks or service marks of their respective holders.

SPECIFICATIONS SUBJECT TO CHANGE WITHOUT NOTICE

**FURUNO ELECTRIC CO., LTD.**  
Nishinomiya, Hyogo, Japan  
www.furuno.com

**FURUNO U.S.A., INC.**  
Camas, Washington, U.S.A.  
www.furunousa.com

**FURUNO (UK) LIMITED**  
Havant, Hampshire, U.K.  
www.furuno.co.uk

**FURUNO NORGE A/S**  
Ålesund, Norway  
www.furuno.no

**FURUNO DANMARK A/S**  
Hvidovre, Denmark  
www.furuno.dk

**FURUNO SVERIGE AB**  
Västra Frölunda, Sweden  
www.furuno.se

**FURUNO FINLAND OY**  
Espoo, Finland  
www.furuno.fi

**FURUNO POLSKA Sp. z o.o.**  
Gdynia, Poland  
www.furuno.pl

**FURUNO DEUTSCHLAND GmbH**  
Rellingen, Germany  
www.furuno.de

**FURUNO FRANCE S.A.S.**  
Bordeaux-Mérignac, France  
www.furuno.fr

**FURUNO ESPAÑA S.A.**  
Madrid, Spain  
www.furuno.es

**FURUNO ITALIA S.r.l.**  
Genoa, Italy

**FURUNO HELLAS S.A.**  
Glyfada, Greece  
www.furuno.gr

**FURUNO (CYPRUS) LTD**  
Limassol, Cyprus  
www.furuno.com.cy

**FURUNO EURUS LLC**  
St. Petersburg, Russian Federation  
www.furuno.ru

**FURUNO SHANGHAI CO., LTD.**  
Shanghai, China  
www.furuno.com/cn

**FURUNO CHINA CO., LTD.**  
Hong Kong

**FURUNO KOREA CO., LTD.**  
Busan, Korea

**FURUNO SINGAPORE PTE LTD**  
Singapore  
www.furuno.sg